





455W **LB**
Series





 Higher power generation better LCOE

 n-type with very Lower LID

 Better Temperature Coefficient

 Better low irradiance response

 25-year product warranty

 30-year linear power output warranty

**n-type Bifacial Double Glass
High Efficiency Mono Module
JAM54D41 LB**

430-455

Comprehensive Certificates

- IEC 61215, IEC 61730
- ISO 9001: 2015 Quality management systems
- ISO 14001: 2015 Environmental management systems
- ISO 45001: 2018 Occupational health and safety management systems
- IEC 62941: 2019 Terrestrial photovoltaic (PV) modules - Quality system for PV module manufacturing





455W

430-455
 JAM54D41

LB Series

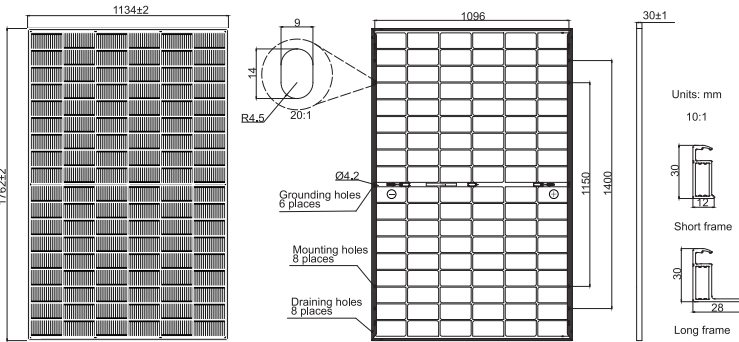

Remark: customized frame color and cable length available upon request

Cell	Mono-16BB
Weight	22kg
Dimensions	1762±2mm×1134±2mm×30±1mm
Cable Cross Section Size	4mm ² (IEC), 12 AWG (UL)
No. of cells	108(6×18)
Junction Box	IP68, 3 diodes
Connector	QC 4.10-351/ MC4-EVO2A
Cable Length (Including Connector)	Portrait: 300mm(+)/400mm(-); 800mm(+)/800mm(-)(Leapfrog) Landscape: 1200mm(+)/1200mm(-)
Front Glass/Back Glass	1.6mm/1.6mm
Packaging Configuration	36pcs/Pallet, 936pcs/40HQ Container

ELECTRICAL PARAMETERS AT STC

TYPE	JAM54D41 -430/LB	JAM54D41 -435/LB	JAM54D41 -440/LB	JAM54D41 -445/LB	JAM54D41 -450/LB	JAM54D41 -455/LB
Rated Maximum Power(Pmax) [W]	430	435	440	445	450	455
Open Circuit Voltage(Voc) [V]	38.50	38.70	38.90	39.10	39.30	39.50
Maximum Power Voltage(Vmp) [V]	32.12	32.29	32.47	32.65	32.82	33.00
Short Circuit Current(Isc) [A]	14.14	14.23	14.31	14.40	14.48	14.56
Maximum Power Current(Imp) [A]	13.39	13.47	13.55	13.63	13.71	13.79
Module Efficiency [%]	21.5	21.8	22.0	22.3	22.5	22.8
Power Tolerance	0~+5W					
Temperature Coefficient of Isc(α _{Isc})	+0.046%/ C					
Temperature Coefficient of Voc(β _{Voc})	-0.260%/ C					
Temperature Coefficient of Pmax(γ _{Pmp})	-0.300%/ C					
STC	Irradiance 1000W/m ² , cell temperature 25 °C, AM1.5G					

Superior Warranty

1% 1st-year Degradation
 0.4% Annual Degradation Over 30 years

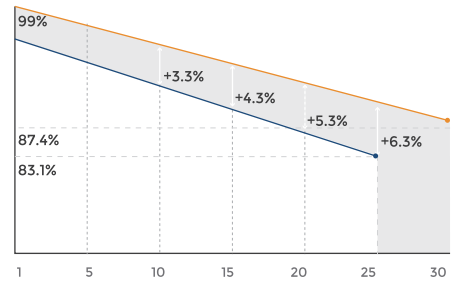

- n-type Bifacial Double Glass Module Linear Performance Warranty
- Standard Module Linear Performance Warranty

*Subject to the terms and conditions contained in the Limited Warranty Statement. Also this 25-year limited product warranty is available only for products installed and operating on residential rooftops in certain regions.

ELECTRICAL CHARACTERISTICS WITH 10% SOLAR IRRADIATION RATIO

TYPE	JAM54D41 -430/LB	JAM54D41 -435/LB	JAM54D41 -440/LB	JAM54D41 -445/LB	JAM54D41 -450/LB	JAM54D41 -455/LB
Rated Max Power(Pmax) [W]	464	470	475	481	486	491
Open Circuit Voltage(Voc) [V]	38.50	38.70	38.90	39.10	39.30	39.50
Max Power Voltage(Vmp) [V]	32.11	32.29	32.47	32.65	32.82	32.99
Short Circuit Current(Isc) [A]	15.27	15.36	15.46	15.55	15.64	15.73
Max Power Current(Imp) [A]	14.46	14.55	14.63	14.72	14.81	14.89
Irradiation Ratio (rear/front)	10%					

*Bifaciality=Pmax,rear/Rated Pmax,front

OPERATING CONDITIONS

Maximum System Voltage	1500V DC
Operating Temperature	-40 °C ~+85 °C
Maximum Series Fuse Rating	30A
Maximum Static Load,Front	5400Pa(112 lb/ft ²)
Maximum Static Load,Back	2400Pa(50 lb/ft ²)
NOCT	45±2 °C
Bifaciality*	80%±10%
Fire Performance	UL Type 38

CHARACTERISTICS

Current-Voltage Curve JAM54D41-440/LB

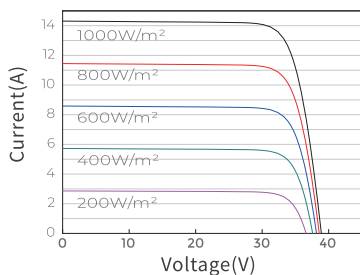

Power-Voltage Curve JAM54D41-440/LB

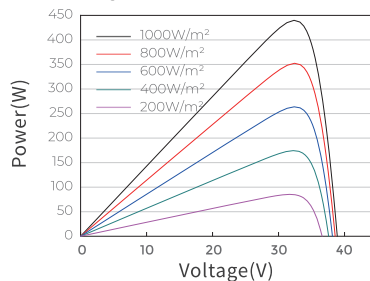

Current-Voltage Curve JAM54D41-440/LB

