



Eve Single

Manual / Handleiding / Handbuch / Manuel / Käyttöopas

S-line
Pro-line

EVE SINGLE S-LINE

OUTSIDE / BUITENZIJDE/ AUSSEN / EXTÉRIEUR / ULKOPUOLELLA

model with charging cable / model met laadkabel /
Modell mit Ladekabel / modèle avec câble de
recharge / latauskaapelilla varustettu malli

model with socket / model met stopcontact /
Modell mit Steckdose / modèle avec prise /
pistorasialla varustettu malli

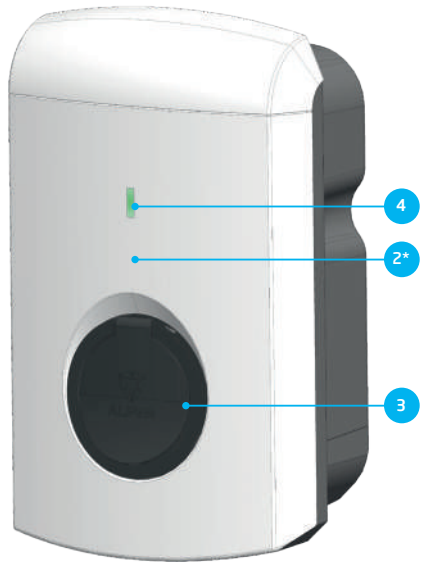
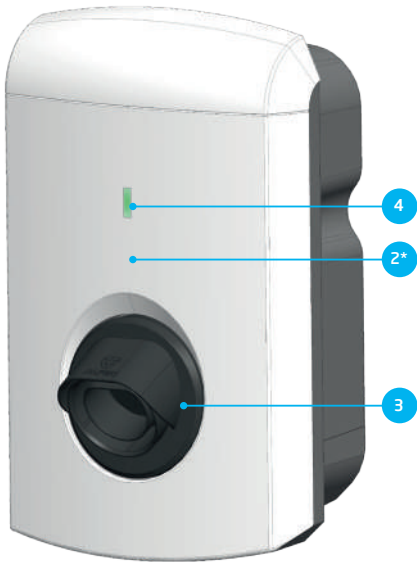

INSIDE / BINNENZIJDE / INNENSEITE /
INTÉRIEUR / SISÄPUOLI

BOTTOM / ONDERZIJDE / UNTERSEITE /
FACE INFÉRIEURE / ALUPUOLI

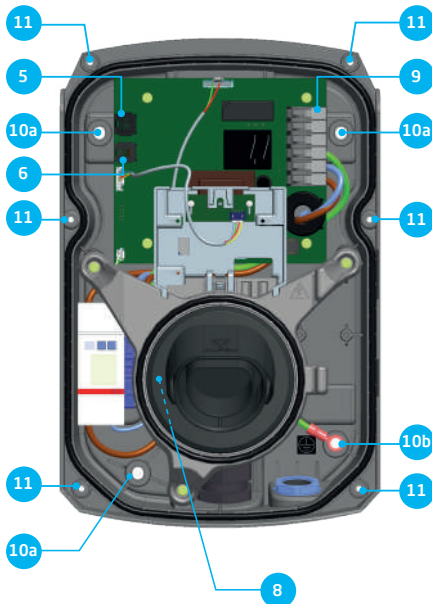

EVE SINGLE PRO-LINE

Exterior view / Buitenzijde / Aussenansicht / Extérieur / Ulkopuolella

model with charging cable / model met laadkabel /
Modell mit Ladekabel / modèle avec câble de
recharge / latauskaapelilla varustettu malli

model with socket / model met stopcontact /
Modell mit Steckdose / modèle avec prise /
pistorasialla varustettu malli



BOTTOM / ONDERZIJDE / UNTERSEITE /
FACE INFÉRIEURE / ALUPUOLI

INSIDE / BINNENZIJDE / INNENSEITE /
INTÉRIEUR / SISÄPUOLI

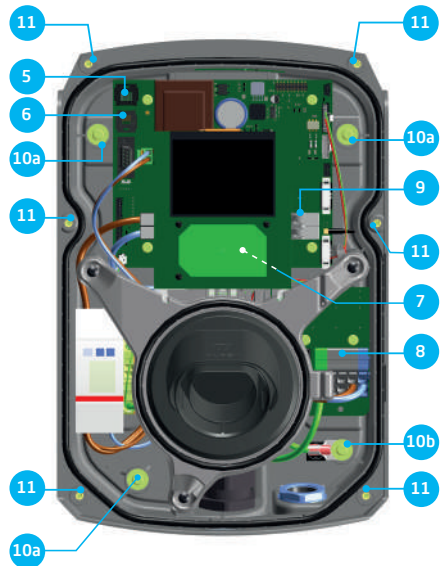

Step-by-step Eve Single installation and commissioning

Congratulations on your purchase of an Alfen charging station for electric vehicles!

To ensure safe installation, and full utilisation, of all advanced features of your charging station, we recommend that you read this manual carefully and save it for future reference.

While we have done our utmost to provide you with a complete and comprehensive manual, it may occasionally be subject to updates and content improvement. The latest version will always be available for download at: www.alfen.com/en/eve-single.

TABLE OF CONTENT

1	Safety and usage instructions	7
1.1	Purpose and intended audience	7
1.2	General safety	7
1.3	Disclaimer	7
2	Product	8
2.1	The charging station	8
2.2	User interface	9
2.2.1	Status indications on S-line models	9
2.2.2	Status indications on Pro-line models	9
2.3	Operation	10
2.4	Access control for local authorisation (RFID)	12
2.4.1.	Installing the Master Key	12
2.4.2	Adding and removing passes in the local database	12
2.4.3	Removing the Master Key	13
2.5	Technical specifications	13
2.5.1	Eve Single models	13
2.5.2	Specifications of Eve Single product lines	13
2.5.3	S-line specifications	13
2.5.4	Pro-line specifications	14
2.5.5	General product specifications	14
2.5.6	Communication and protocols	15
2.5.7	Information safety	15
2.5.8	Available memory	15
2.5.9	User circumstances	15
2.5.10	Casing	16
2.5.11	Installation instructions	17
2.5.12	External protection according to EV/ZE-Ready	17
2.6	Optional factory settings	18
2.7	Accessories	18
3	Assembly and connecting	19
3.1	Installing and connecting	19
3.2	Assembly and installation requirements	20
3.3	Mechanical installation	20
3.4	Electrical installation	21
4	Commissioning the charging station	23
4.1	Safety instructions before use	23
4.2	Commissioning S-line models	23
4.3	Commissioning Pro-line models	23
4.4	Configuring the charging station with Service Installer (application)	23
4.4.1	Preparation	23
4.4.2	Using the Service Installer application	24
4.4.3	Changing language settings (Pro-line models)	24
4.5	Activate functionality with the Service Installer application	24
5	Connectivity	25
5.1	Management systems	25

5.2	Setting up a connection	25
5.2.1	Wireless connection	25
5.2.2	UTP (Ethernet) connection	25
5.3	Register your ICU EZ account	26
5.4	Managing settings	26
5.5	Register your charging station to your own management system	26

Appendices

Appendix A: Error codes and problem-solving	27
Appendix B: Default selections for optional factory settings	30

DECLARATION OF CONFORMITY

Manufacturer information:

Alfen ICU B.V.
Hefbrugweg 28
1332 AP Almere
The Netherlands

Declares that the charging station of the type **Alfen Eve Single (S-line, Pro-line)**, to which this declaration applies, **complies with:**

- 1) The provisions of the low voltage directive 2014/35/EU
- 2) The provisions of the EMC guideline 2014/30/EU
- 3) The following harmonised standards:
 - IEC 61851-1 ed. 3 (2017)- Electric vehicle conductive charging system - General requirements, implemented at a national level with:
 - AT: ÖVE/EN 61851-1
 - BE: NBN EN 61851-1
 - DE: DIN-EN 61851-1
 - FIN: SFS-EN 61851-1
 - FR: NF-EN 61851-1
 - NL: NEN-EN-IEC 61851-1
 - NO: NEK-EN-61851-1
 - UK: BS-EN 61851-1

All mentioned products are labelled with the CE mark.

Almere, The Netherlands, 3 January 2019.



Ir. M. Roeleveld
CEO

1.1 Purpose and intended audience

The Alfen Eve Single is intended exclusively for charging electric vehicles and, when installed correctly, may be used by untrained individuals. Make use of this manual to properly install and commission the charging station.

Installation, commissioning and maintenance of this installation may only be performed by a qualified electrician (Alfen-ICU certified partner). It is essential that the qualified technician has:

- Expertise on all relevant general and specific rules regarding safety and incident prevention
- Comprehensive knowledge of applicable electrical regulations.
- The ability to identify risks and avoid potential hazards.
- Received and read these installation and operation instructions

This manual applies to the product Eve Single S-line and Pro-line, equipped with firmware version 4.14.

1.2 General safety



DANGER!

These safety instructions are important to ensure safe operation. Failure to comply with them in accordance with general electrical safety regulations could result in a risk of electrical shock, fire and/or life threatening injury.

Using this product is expressly prohibited in the following situations:

- In the vicinity of explosive or highly flammable substances.
- If the product is located in or close to water.
- If the product or its individual components are damaged.
- Usage by children or individuals not able to properly assess the risks associated with using this product.

Alfen ICU B.V. shall not be liable in any way, for any kind of damage, and all warranties on both the product and accessories shall become void where:

- There has been a failure to comply with the instructions in this manual.
- Improper use.
- Installation and commissioning has been undertaken by unqualified persons.
- The product or accessories have been expanded or modified without our knowledge.
- Replacement parts have been used that are not approved or manufactured by Alfen.
- The ambient temperature is below -25 °C or above 40 °C.
- Situations have occurred that are beyond our control.

More extensive safety information is available in the relevant sections of this document.

1.3 Disclaimer

This manual applies to all Eve Single products produced by Alfen. Any deviation to the default Eve Single products as defined by Alfen including, but not limited to, customer-specific modifications (like customisation by placing stickers, SIM cards or the usage of different colours), hereafter referred to as 'Customisation', can alter the final product experience, product appearance, product quality and/or product lifespan. Alfen is not liable for any damage to, or caused by, the product (including applied Customisation) if this damage is caused by this applied Customisation. Contact your dealer for more information on Customisation versus the default product.

2. PRODUCT

2.1 The charging station

On pages 2 and 3 of this manual, you will find the images of the Eve Single S-line and Pro-line product lines. In this chapter, you will find more information on the contents of these charging stations and how they can be used to charge your vehicle.

S-line (page 2)

Outside

- ② RFID card reader (optional S-line 3-phase)
- ③ Type 2 socket (shutter optional) or plug holder
- ④ RGB Status LED

Inside

- ⑤ UTP (Ethernet) connector
- ⑥ RJ11 connector
- ⑧ Terminal block for the power cable
- ⑨ Clamps for outbound charging cable (model without outlet)
- ⑩ a. Screws for wall-mounting frame
- ⑩ b. Screws for wall-mounting frame with earth connection
- ⑪ Screws for front cover

Bottom

- ⑫ Identification label
- ⑬ Cable screw connection (cable gland) for the power cable
- ⑭ Cable screw connection (cable gland) for charging cable
- ⑮ Wall-mounting frame
- ⑯ Grommet for UTP cable/Ethernet cable
- ⑰ Grommet for P1 cable

Pro-line (page 3)

Outside

- ① Colour display
- ② RFID card reader
- ③ Type 2 socket (shutter optional) or plug holder

Inside

- ⑤ UTP (Ethernet) connector
- ⑥ RJ11 connector
- ⑦ SIM cardholder
- ⑧ Terminal block for the power cable
- ⑨ Clamps for outbound charging cable (model without outlet)
- ⑩ a. Screws for wall-mounting frame
- ⑩ b. Screws for wall-mounting frame with earth connection
- ⑪ Screws for front cover

Bottom

- ⑫ Identification label
- ⑬ Cable screw connection (cable gland) for the power cable
- ⑭ Cable screw connection (cable gland) for charging cable
- ⑮ Wall-mounting frame
- ⑯ Grommet for UTP cable/Ethernet cable
- ⑰ Grommet for P1 cable

Identification label

The identification label ⑫ found on the bottom of the charging station specifies elements such as:

- Model, production date and serial number.
- Technical specification number.
- Article number and maximum charging current.

When contacting Alfen, always have your serial number available to facilitate quick support.

2.2 User interface

The Eve Single has two different versions: The S-line with a Status LED and the Pro-line with a colour display. Both versions inform the user on the progress of the charging by using status indications.

2.2.1 Status indications on S-line models

General status indications

LED		Stand by, ready to use		Charge card accepted, cable connected		Communicating with vehicle or charging complete		Charging transaction active
-----	--	------------------------	--	---------------------------------------	--	---	--	-----------------------------

Status indicators during smart EV charging (load balancing)

The Eve Single S-line will indicate activated smart charging features e.g. load balancing (for more information, see Appendix B) in the following way:

LED		Load balancing off		Load balancing activated: reduced charging		Load balancing activated: charging paused
-----	--	--------------------	--	--	--	---

Status indications for errors

Any user error or fault will be indicated by a red LED status.

LED		The charging station detected an error. Contact our service department.		Charge card presented is not authorised for charging. Charging cable is connected but no charging is happening
-----	--	---	--	--

2.2.2 Status indications on Pro-line models

General information on charging station

- ① The charge point ID: Identification is determined by the reseller or maintainer of the central management system. You can, for example, use this ID to convey to a helpdesk for which charging point you need support.
- ② Date and time: these are set through a maintenance system (automatically) or during installation, using the Service Installer application. If the product does not have a current time, this field is invisible.

Status and information screen

Status and information screen: the charging station informs the user of its current status

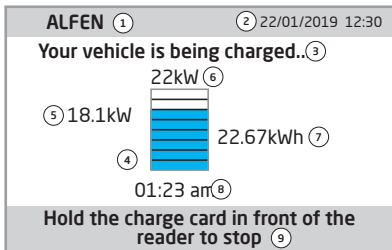

Figure 1: Display of Eve Single Pro-line during charging

and provides the user with a response to the actions performed. The following information is available:

- ③ Status information
- ④ Status indicator (symbols, see figure 2)
- ⑤ Current charging capacity to the connected vehicle
- ⑥ Maximum charging capacity of the outlet
- ⑦ Energy picked up during the current transaction
- ⑧ Duration of the current transaction

Instruction field

- ⑨ Usage instructions will be displayed in this location. Where an error occurs, an error code and instruction will be shown (see Appendix A for more information).

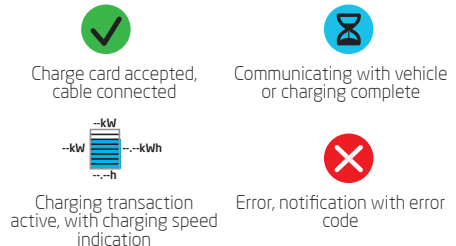

Figure 2: Symbols status indicator

2. PRODUCT

2.3 Operation

Specific user actions are presented in a sequence that clearly shows the progress and corresponding status indications. The first steps can be conducted in any sequence. Upon detecting a charging cable or charge card, all Eve Single products will show a green status. The light blue (cyan) colour will only be displayed if and when a connection between the vehicle and charging station is established.

Start

Operation Plug & Charge - Authorisation without a charge pass

Models with fixed charging cable



S-line



Pro-line



Models with socket



S-line



Pro-line



Stop

Models with fixed charging cable



S-line



Pro-line



Models with socket



S-line



Pro-line



Start

RFID - Charging station with user authorisation

Models with fixed charging cable



S-line

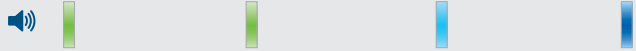

Pro-line

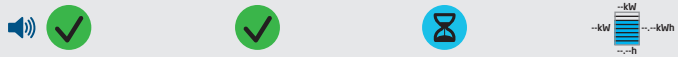

Models with socket



S-line

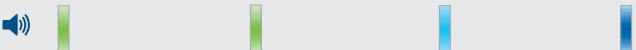

Pro-line

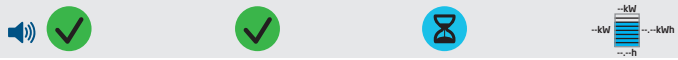

Stop

Models with fixed charging cable



S-line

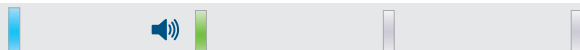

Pro-line

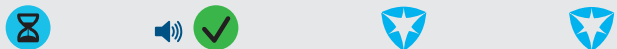

Models with socket



S-line

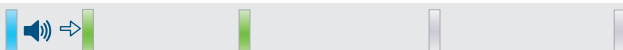

Pro-line

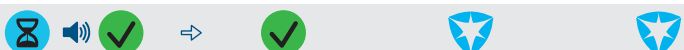

2. PRODUCT

2.4 Access control for local authorisation (RFID)

To control local user access to an Alfen Eve Single charging station, you need to install an RFID card as the 'Master key'. With this Master Key, you can determine who can use your charging station.

REMARK

Your charging station must be configured correctly in order to accept Master Keys. For stand-alone charge points this functionality is automatically ON. If the charging station is delivered with a pre-programmed management system, this functionality will be OFF.

2.4.1. Installing the Master Key

A Master Key can be easily installed using the following steps:

- ① Select an RFID card, like the included Alfen pass, that complies with the specifications mentioned in paragraph 2.5.4.
- ② Hold the RFID card in front of the card reader for 10 seconds. The charging station does not recognise the pass and will give a warning first. You can ignore this.
- ③ After 10 seconds, the RFID card will be registered as the Master key. The following icon appears on the screen:



NOTICE!

The Master Key cannot be used for charging. It is only used for access control of the charging station.

The charging station will only recognise one RFID card as the Master Key.

2.4.2 Adding and removing passes in the local database

Once the Master Key is registered, it can be used to add or remove charging passes from the local database. For every pass held in front of the charging station, the station will give a sound signal. Follow the on-screen instructions to manage access control:

Hold the Master Key in front of the card reader

Hold the charge pass that you want to add in front of the card reader

Hold the charge pass that you want to remove in front of the card reader

Display



Supporting text on display

Master Key held in front of reader
Add or remove charge passes

Card added

Card removed

If you add or remove a charge pass in error, you can immediately hold it in front of the card reader to undo the action.

To close the database, hold the Master Key in front of the card reader once more.

REMARK

To prevent the local database from being 'open' to access control, the menu will close automatically if no card has been detected or removed after 10 seconds. The symbol will disappear from the display.

2.4.3 Removing the Master Key

A Master Key can only be removed using the Service Installer application. If necessary, you can ask for help from one of our technicians. This might, however, incur costs. Therefore, always keep the Master Key in a safe location. More information on the use of the Service Installer application can be found in paragraph 4.4.

2.5 Technical specifications

2.5.1 Eve Single models

Models

S-line

Eve Single S-line, 1 phase

Eve Single S-line, 3 phase

Pro-line

Eve Single Pro-line, 1 phase

Eve Single Pro-line, 3 phase

2.5.2 Specifications of Eve Single product lines

Eve Single model overview	S-line 1 phase	S-line 3 phase	Pro-line 1 phase	Pro-line 3 phase
1 phase	•	•	•	•
3 phase	-	-	•	•
RFID card reader	-	Optional*	•	•
RGB LED	•	•	-	-
Display	-	-	•	•
Energy meter	MID certified	MID certified	MID certified	MID certified
Max. 6mA DC detection	•	•	•	•
Mobile network communication	-	Optional*	•	•
Ethernet/LAN dedicated network connection	•	•	•	•

* Optional features are mutually exclusive and only available on 3-phase models.

2.5.3 S-line specifications

Operation	Plug & Charge authorisation RFID authorization (optional with 3-phase model) Central system Third-party apps
Mobile network possibilities	GPRS (optional with 3-phase model)
Status indication	RGB LED

2. PRODUCT

2.5.4 Pro-line specifications

Operation	Plug & Charge authorisation RFID authorisation Central system Third-party apps
Display	3.5" TFT colour display, 320 x 240 pixels
RFID card reader	RFID (NFC) ISO/IEC 14443A/B, MiFare Classic 13.56 MHz, DESFire Maximum length: 7 bytes
Mobile network possibilities	GPRS
Energy meter	MID certified
Status indication	Integrated in the display

2.5.5 General product specifications

Number of outlets	1
Types of outlets	Fixed cable Type 2 socket, in accordance with IEC62196-2 Type 2 socket shutters, in accordance with IEC62196-2, ed. 2
Supported power systems	TN-C, TN-C-S, TT
Nominal output voltage (+/- 10%)	230V, 1-phase products 400V (3x230V), 3-phase products
Maximum design current	32A per phase
Maximum design power	7.4kW, 1-phase products 22kW, 3-phase products
Connection clamps	Cable gland, clamping range for 14-25.5mm cable thickness Cable clamps on input filter block. Range: <ul style="list-style-type: none"> • 10mm² per vein: solid (VD) wire • Max. 6mm² per vein: stranded (VDS) wire with ferrules
Activation relay	Integrated, simultaneous activation Extra safety relay in series
Overcurrent protection	Integrated in firmware; shutdown at: 105% after 1,000 seconds; 110% after 100 seconds; 120% after 10 seconds; 150% after 2 seconds.
Residual current protection	Integrated 6mA DC leakage current detection Response time: 1-5 seconds
Available in- and outputs	RJ45 (Ethernet/LAN) RJ11 (active load balancing)



NOTICE!

Alfen Eve Single charge stations contain a 6mA DC detector that protects the earth leakage circuit breaker against DC leakage currents. The DC detector prevents type A earth leakage circuit breakers from becoming 'blind' to dangerous leakage currents. The charging station will repond well in advance of any dangerous situation (6mA vs 30mA). Instead of jumping the earth leakage circuit breakers, the charging station will stop the charging process in a controlled manner if leakage currents are detected. After a time-out, and provided that the 6mA leakage current is no longer measured, the charging process will be restarted. Three restarts are possible before the charging process is stopped permanently and an error code is displayed. This function does not, nor will it ever, replace an earth leakage circuit breaker and cannot be tested as such by the installer. If legislation and regulations require a type B earth leakage circuit breaker to be installed, regardless of the presence of a 6mA DC detector, this can be installed without any problems.

2.5.6 Communication and protocols

Controller	Central unit for charging currents and communication
Vehicle communication	Mode 3 in accordance with IEC 61851-1 ed. 3 (2017)
Internet/networking possibilities	Mobile network communication, Ethernet/LAN
Communication protocol Central System	OCPP 1.5 (JSON), OCPP 1.6 (JSON)
Supported RJ45 protocols	OCPP TCP/IP
Supported RJ11 protocols	DSMR 4.0-4.2 and SMR5.0 (P1 port) I/O for supporting external relay
Modbus (Master)	TCP/IP

2.5.7 Information safety

SIM card	Mini SIM card APN username and password
Central System authentication	TLS 1.2 x509 2048/4096 bit root certificate
EVSE authentication	HTTP Basic authentication, with or without TLS
Remote console access (SSH, telnet)	Not supported
Diagnostic files	Encryption: AES 128 bit
Firmware update files	Encrypted and digitally signed Encryption: SHA256 hash (pkcs1/PSS padding with 2048 RSA key) Signature: RSA public key 2048 bit
EVSE Internal Flash	AES 128 bit (erased when read)
Root certificate	Installed in the factory, update through UpdateFirmware file

For more information on the implementation of information security in Alfen Charging Equipment, you can contact cpadmin@alfen.com

2.5.8 Available memory

Charge passes	Local list: approx. 800 charge passes (via the Backend) White list: approx. 1,200 charge passes (local)
Transaction database	Approx. 1,500 transactions (of 4u with 15min Wh-metering values)
Logging for diagnostics	Approx. 45,000 lines

2.5.9 User circumstances

Operating temperature	-25°C - 40°C
Relative atmospheric humidity	5 - 95 %
Electrical safety class	I
Degree of protection (casing)	IP55
IK protection (mechanical impact)	IK10
Stand-by use	S-line 1-phase: approx. 3.5 - 3.8W S-line 3-phase: approx. 3.9 - 4.1W Pro-line 1-phase: approx. 3.5 - 3.8W Pro-line 3-phase: approx. 3.9 - 4.1W

2. PRODUCT



NOTICE!

The operating temperature assumes the ambient temperature of a product delivered in the default casing colour 'RAL9016'. Direct exposure to sunlight may have an adverse effect on the temperature range.

The ambient temperatures in the table above refer to a product in its default casing, colour RAL9016. Other (darker) colours may have an adverse effect on the product. If the product is exposed to lower or higher temperatures, continuous operation cannot be guaranteed. If temperatures exceed the maximum values, the charging station will automatically decrease the charging current to decrease the internal temperature.

This stabilises the internal temperature and makes it less likely that a transaction will be unexpectedly paused.

If the product is directly exposed to sunlight, the automated temperature management may automatically start below the maximum ambient temperature.

2.5.10 Casing

Type	Wall-mounted unit
Mounting options	Wall mounting or mounting post (accessory)
Material	Polycarbonate, UV resistant and flame retardant
Colour	RAL9016 (Traffic White): front side RAL 7043 (Traffic Grey B): rear
Locking	Torx T20 screws
Dimensions (H x W x D)	
Casing	370 x 240 x 130mm
Packaging	460 x 315 x 250mm (models with socket)
Packaging	480 x 340 x 360mm (models with charging cable)
Weight	
Casing	Approx. 4 kg
Total, incl. packaging	Approx. 4.5 kg



NOTICE!

Where products are exposed to the elements, the case can be subject to gradual aging of the material, which can result in product discolouration over time. Therefore, wherever possible, place the product in a sheltered place to optimise the life of the materials.

2.5.11 Installation instructions



NOTICE!

Your installation must comply with the standards and regulations of the location (country) where it is installed. The tables below are advisory and based on the proper practical functioning of the charging stations, provided all necessary conditions have been satisfied.

Printing errors are expressly reserved

Input: minimal recommended cable diameters (based on assumed max. 50m cable length)	1-phase 3.7kW charging, 16A per phase: 3 x 4 mm ² . 3-phase 11kW charging, 16A per phase: 5 x 4 mm ² . 1-phase 7.4kW charging, 32A per phase: 3 x 6 mm ² . 3-phase 22kW charging, 32A per phase: 5 x 6 mm ² .
Short-circuit protection	With breaker circuits: 1-phase 16A (3.7kW): 1 x 20A, 1P, type B or C 3-phase 16A (11kW): 1 x 20A, 3P, type B or C 1-phase 32A (7.4kW): 1 x 40A, 1P, type B or C 3-phase 32A (22kW): 1 x 40A, 3P, type B or C with fuses: 1-phase 16A (3.7kW): 1 x 20A gG 3-phase 16A (11kW): 3 x 20A gG 1-phase 32A (7.4kW): 1. x 35A gG 3-phase 32A (22kW): 3 x 35A gG
Residual current protection (possibly i.c.w. circuit breakers)	Earth leakage circuit breakers: 30mA type A or B, 4P 3.7kW/11kW charging: minimum 20A 7.4kW/22kW charging: 40A For specific EV/ZE Ready installations, see paragraph 2.5.12 for detailed specifications and related requirements for the installation.
Nominal input voltage	<ul style="list-style-type: none"> • $V_{L1-N'}$: 230V (+/-10%) • $V_{L2-N'}$: 230V (+/-10%) • $V_{L3-N'}$: 230V (+/-10%) • V_{L1-L2}: 400V (+/-10%) • V_{L1-L3}: 400V (+/-10%) • V_{L2-L3}: 400V (+/-10%) • $V_{PE-N'}$: ≈ 0V
Nominal frequency	50/60 Hz
Grounding	TN system: PE cable TT system: separately installed grounding electrode < 100 Ohm spreading resistance)

2.5.12 External protection according to EV/ZE-Ready



NOTICE!

An installation in accordance with the EV/ZE Ready standard requires a high immunity type Residual Current Breaker (if a type A RCD is applied). The RCD must comply with Level 4 specifications.

IEC 61000-4-16 or IEC 61543

Frequency range	Level 3		Level 4	
	Cont. test Vrms (V)	Current (mA)	Cont. test Vrms (V)	Current (mA)
1 kHz - 1.5 kHz	1	6.6	3	20
1,5 kHz - 15 kHz	1 - 10	6.6 - 66	3 - 30	2 - 200
15 kHz - 150 kHz	10	66	30	200

2. PRODUCT

2.6 Optional factory settings

Description	Options
Authorisation	Plug & Charge, RFID*
Maximum charging current	16A, 32A* (only Pro-line)
Smart Charge options (see Appendix B)	Off Active load balancing (P1)* Smart Charging Network*
Own logo in display (only Pro-line)	Off (Alfen logo) On (your own logo)
Languages supported (only Pro-line)	English, Dutch, German, French, Spanish, Portuguese, Italian, Norwegian, Swedish, Finnish
User availability if temporarily offline	Accept all RFID passes Only valid passes in database Not available
Action if plug is released on vehicle side	Stop transactions and release the plug Pause charging until cable plugged back in
Choice of management system	Stand alone, ICU Connect*, other options*
Communication through *	GPRS, UTP/LAN (only Pro-line), Autodetect (only Pro-line)

* Settings may incur additional costs.
The default settings are always displayed first.











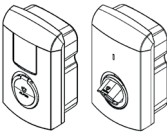



2.7 Accessories

Mounting post	Art. 803873036-ICU
Pole dimensions (H x W x D) Base plate (L x W x H)	1.180 x 60 x 120mm 300 x 200 x 5 mm
Material	SAE 304 stainless steel, Fine-structure powder coating
Colour	RAL 7043 (Traffic Grey B)
Packaging (H x W x D)	1200 x 340 x 220 mm
Weight	12 kg
Type 1 charging cable, 5m, 1 phase, up to 32A (7.4kW)	Art. 203100301-ICU
Type 2 charging cable, 5m, 1 phase, up to 32A (7.4kW)	Art. 203100306-ICU
Type 1 charging cable, 8m, 1 phase, up to 32A (7.4kW)	Art. 203100302-ICU
Type 2 charging cable, 8m, 1 phase, up to 32A (7.4kW)	Art. 203100303-ICU
Type 2 charging cable, 5m, 3 phase, up to 32A (22kW)	Art. 203100304-ICU
Type 2 charging cable, 8m, 3 phase, up to 32A (22kW)	Art. 203100305-ICU
Extra RFID card	Art. 203120010-ICU

3. ASSEMBLY AND CONNECTING

Package contents

Contents of the charging station package: Alfen Eve Single, installation manual, wall-mounting frame, installation supplies and RFID charge passes (depending on options selected)

1 x	1 x	1 x	1 x	1 x	2 x		
							
Eve Single S-line Eve Single Pro-line	Wall-mounting frame	This manual	Quick Installation Guide	M25 x 1.5 (For model with socket)	M25 x 1.5 (For model with fixed cable)		
4 x	4 x	4 x	4 x	6 x	1 x	1 x	1 x
							
Screw 5 x 50mm	Plug 4.5-5 8mm	M8 nut	M8 washer	Torx screw M4 x 8mm	Reduction fitting M32 x 1.5	Filler washer for the cable gland	Torx T20 wrench

3.1 Installing and connecting

Read these instructions carefully before installing the charging station. Alfen ICU B.V. is not liable for any consequential damage caused by failure to follow the instructions in this manual.

REMARK

The installation needs to be performed by a qualified electrician who has read this manual and will execute the installation in accordance with the IEC 60364 (Electrical Installations for Buildings) standard. Failure to do so may lead to injury or cause electrical health and safety risks.

REMARK

Work on the charging station may not be carried out if the atmospheric humidity exceeds 95%.

REMARK

A charging station must always be installed on a power circuit intended for that purpose.

DANGER!

Installing the station incorrectly may result in fatal injury! When working with electricity, failure to comply with relevant regulations can lead to dangerous and life-threatening situations.

DANGER!

The charging station contains electrical components that still contain a charge after being disconnected from the system. Always wait 10 seconds after disconnecting before beginning to work.

3. ASSEMBLY AND CONNECTING



DANGER!

The electrical system must be disconnected from every power source before performing any installation or maintenance work!

3.2 Assembly and installation requirements

See the table in paragraphs 2.5.11 and 2.5.12 for the safety options and necessary cable diameters for a proper connection.

Ensure that the following requirements for installing the Eve Single have been met:

- The cable trajectory from the main distributor to the Eve Single must be secured against short-circuiting and overcurrent with:
 - a B- or C-type circuit breaker (or other, in accordance with local standards and regulations), or
 - gG-type fuses (or other, in accordance with local standards and regulations).
- The cable trajectory must be equipped with 30-mA fault current protection with a type A or B earth leakage circuit breaker (type A recommended). The earth leakage circuit breaker must be protected against the maximum current the charging station can process (20A or 40A)
- The cable trajectory and the charging station are part of a TN-S system; the equipment must be earthed at the main distributor or with an earth pin (TT). An energy grid without a neutral conductor is not supported.
- The cable trajectory must be installed in accordance with the usual local professional standards.

REMARK

Local conditions may influence the installation requirements.

REMARK

The installation and cables should be installed to match the maximum charging current to the input of the charging station. This should assume continual load. The cable diameters stated in this manual are indicative. The installer is always responsible for choosing the right cable diameter and complying with the relevant standards and legislation.

While selecting a location to install the Eve, the following criteria must be taken into account:

- Never install in a potentially explosive atmosphere.
- Never install in areas prone to flooding without implementing compensatory measures.
- Always fully comply with local technical requirements and safety regulations.
- An on-site connection is created that complies with the specifications in paragraphs 2.5.11 and 2.5.12.
- The installation site must have a levelled and solid foundation.
- Maximum atmospheric humidity of 95%.

- Ambient temperature of -25 °C - 40 °C.
- A temperature difference within 24 hours < 35 °C.
- The recommended installation height is 80 - 120 cm from the ground to the bottom of the casing.
- The charging port on the vehicle needs to be easy to reach with the (attached) charging cable.
- Ensure that the charging station is placed at a location where users can use their charging cable (approx. 5 - 8 metres) without placing any tension on the cable.
- Prevent other drivers from being able to drive over the cable.
- Prevent pedestrians from tripping over cables.

3.3 Mechanical installation

Use the following tools and equipment to install the Eve Single:

- Spirit level;
- Impact drill with 8mm stone drill bit;
- Cross-head screwdriver (PZ2);
- Cross-head screwdriver (PH4);
- Wire stripper;
- Torx T20 wrench (included);
- 4x 5 x 50mm screw (included);
- 6x M4 x 8mm screw (included);
- 4x plugs 4.5 - 5mm (included);
- 4x M8 washer (included);
- 4x M8 nut (included)

Preparing the charging station

The front cover is firmly attached to the charging station and is secured with two screws on the top, two in the middle and two on the bottom. Prior to the installation, the white front casing must be removed from the charging station. This is done as follows:

1. Place the charging station on the floor, front cover down. Use some soft flooring or protect the casing to prevent scratches or damage to the charging station.
2. Loosen the six screws with the included Torx T20 wrench or T20 screwdriver.
3. Store these screws in a safe place as you will need them later.
4. Put the charging station onto its back.
5. Now carefully pull the front cover upwards to lift it off the charging station.

Installation on a mounting post

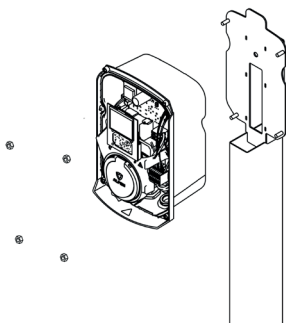

1. Carefully remove the frame from the rear of the casing as it is not required for installation on the mounting post.
2. Place the Eve Single over the threaded ends on the mounting post. Even though the product will be supported by the post directly, hold the charging station to prevent the station from falling and getting damaged.
3. Attach the Eve Single to the pole with the M8 nuts included in the package. Place the yellow/green earth wire under the head of the nut on the bottom right before fixing the nut into place (10) b (pp. 2-3)

Wall mounting the charging station

REMARK

Always allow 50cm free space around the charge point to allow for simple placing and removal of the case.

To properly install the charging station, use the frame as a template for the drill holes.

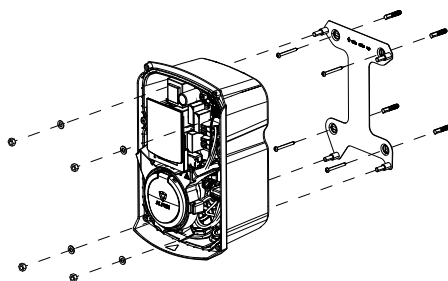

Figure 5: Wall mounting with included frame

1. Remove the strips of adhesive tape to take the frame off the rear of the casing.
2. Hold the frame in the desired location.
3. Use a spirit level to check if the frame is straight.
4. Mark the drilling holes through the holes in the frame.

REMARK

Check the stated sizes with a tape measure. The distances between the drilling holes are: Horizontal, on top: 132mm/horizontal, bottom: 150mm/Vertical: 210.5mm

5. Drill the holes on the marked locations.
6. Put the (nylon) plugs into the four drill holes.
7. Attach the frame of the charging station to the wall with the screws (5 x 50mm) included in the package.
8. Place the Eve Single onto the frame. Even though the product will be directly supported by the frame, hold it firmly to prevent the station from falling and becoming damaged.
9. Attach the Eve Single to the subframe using the M8 washers and M8 nuts included in the package. Place the yellow/green earth wire under the washer and M8 nut on the bottom right before fixing the nut into place.

3.4 Electrical installation



WARNING

Read and follow all of the safety instructions in this manual!



DANGER!

The electrical system must be disconnected from every power source before performing any installation or maintenance work!

3. ASSEMBLY AND CONNECTING

1. Loosen the guide tube (M32) on the bottom, remove the cable gland and disassemble it.
2. Place the ring over the power cable/charging cable.
3. Feed the power cable/charging cable into the charging station and slide the cable gland (and, if needed, the filler washer) and the nut over the cable.
4. Remove the insulation with a wire stripper to reveal the wire cores far enough to fit them into the terminal block.
5. Attach the power cables to the connection clamps of the filter block (see figure 8a and 8b).

For installation of the model with socket, continue with step 11..

6. Remove the cap (14) on page 2).
7. Repeat the previous steps 2 - 4 for the charging cable included in the package.
8. Remove the transparent subframe by removing the three Torx T20 screws. See figure 6

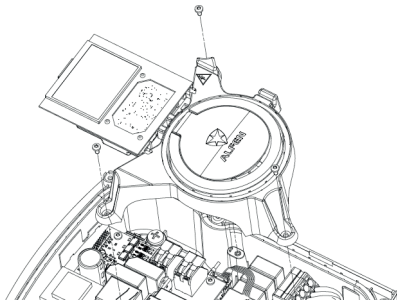

Figure 6: Detach subframe

9. Push the charging cable further in and connect the wires to the outgoing clamps on the platform. Figure 7a shows the connection location for the S-line 1 phase model. See figure 7b for the location on the S-line 3 phase and Pro-line models.

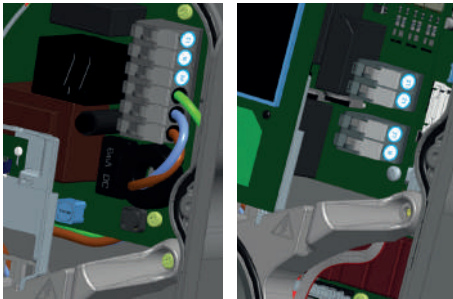

Figure 7a and 7b: Attaching individual charging cable wires on S-line 1 phase models (left) and S-line 3 phase & Pro-line models (right).

10. Attach the Control Pilot (CP) connector to the red connection cable. This is right next to the connection terminal for the power cables. See figure 8a (S-line 1 phase) and figure 8b (S-line 3 phase, Pro-line).

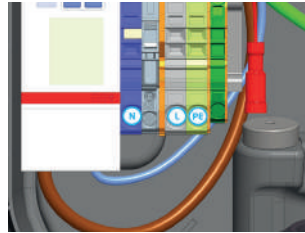

Figure 8a: Connection clamps power and Control Pilot (CP) connector for the charging cable (red) to S-line 1 phase.



Figure 8b: Connection clamps power and Control Pilot (CP) connector for the charging cable (red) to S-line 3 phase, Pro-line.

11. Tighten the cable guide tube firmly so that the power cable/charging cable does not have any slack.
12. Reattach the transparent subframe if you took it off (models with charging cable only)
13. Press the front cover back onto the charging station.
14. Screw the front cover back onto the charging station with the Torx T20 wrench. Use all six screws for this.

REMARK

The Service Installer application is available for download for Microsoft Windows on: www.alfen.com/en/downloads. See the chapter 'Programmes'. If you do not yet have an account to use the Service Installer application, you can request one through <http://support.alfen.com> -> 'Configuration Tool' -> 'Sign up for an account'.

4.1 Safety instructions before use

Follow the safety instructions below before commissioning your charging station:

1. Make sure the charging station is properly connected to the power supply as described in this manual.
2. Make sure the distribution of the power supply is separately protected by an appropriate breaker (automatic or fuse cartridges)
3. Make sure the charging station is installed in accordance with this manual.
4. Make sure the casing is always closed during normal operation.
5. Make sure the charging cable is not twisted and that the cable, plug and casing do not have any damage.

4.2 Commissioning S-line models

Turn on the local power supply. The charging station will run self diagnostics.

The following steps will occur within a few seconds:

1. The output is tested:
 - Testing locks (models with socket)
 - Testing internal relays: you will hear these click
2. The LED will flash red 3 x; 1 x slowly, 2 x briefly.
3. The LED will turn off. Your Eve Single is now ready for use. If the charging station is set to connect with the management system, it will do so instantly and automatically.
4. If desired, the charging station can be configured further. Use the Service Installer software package to gain access.
5. Have you had the charging station configured for Smart Charge functionality? If so, check the settings with the Service Installer application to optimally configure the charging station for the local situation. More information is available in Appendix B.

4.3 Commissioning Pro-line models

Turn on the local power supply. The charging station will run self diagnostics. The following steps will occur within a few seconds:

1. The output is tested:
 - Testing locks (models with socket)
 - Testing internal relays: you will hear these click.
2. The display will illuminate briefly.
3. The display turns on and displays the message 'Charging point is powering up'.
4. The display will show the start screen, recognisable by the logo on the screen.
5. The Eve Single Pro-line is now ready for use. If the charging station is set to connect with the management system, it will do so directly and automatically.
6. If desired, the charging station can be configured further. Use the Service Installer software package to gain access.
7. Have you had the charging station configured for Smart Charge functionality? If so, check the settings with the Service Installer application to optimally configure the charging station for the local situation. More information is available in Appendix B.

4.4 Configuring the charging station with Service Installer (application)

4.4.1 Preparation

Eve Single charging stations are easily configured using the Service Installer application. This application allows you to access many settings, view the factory settings and see all the completed transactions and recognised charge passes.

The version number of the Service Installer application is connected with that of the firmware to show you which new functionalities are supported by your charging station.

Tip: Before installing the charging station, make sure you have a user account and are using the newest version of the Service Installer application. You can request an account at: <http://support.alfen.com>. Click on 'Sign up for an account'. Note that new account creation may take several working days











Connect the charging station to your laptop with an Ethernet cable (UTP).

4. COMMISSIONING THE CHARGING STATION

4.4.2 Using the Service Installer application

When you log in, you will see the charging station settings divided into different categories. In most cases, the charging station has already been configured according to preferences with few adjustments necessary. If you ordered the smart charge optionS (see Appendix B) , check the settings and adjust them where necessary to optimally configure the charging station for its location.

The Service Installer application is divided into the following categories:

	General charging stations settings and status information		Settings on the user interface, such as LED colours (S-line) and the display (Pro-line)
	Power settings to configure the charging station for the local grid		Load balancing, all of the smart charging options and settings in one location
	Authorisations: managing charge passes and methods for user authorisation		Activity log of the charging station
	Transaction information for historic and current transactions		Live monitoring: Take a look at the status of the charging station
	Connectivity settings e.g management system connection settings (see paragraph 4.4), mobile communication (GPRS) and local network settings.		Warnings: shown in a single overview for quick analysis

Functionalities shown in grey were not specified when ordering and so the charging station does not support them.

4.4.3 Changing language settings (Pro-line models)

Alfen's charging station interface supports ten different languages.

Changing the language can be done in two ways:

1. Via the Service Installer application; proceed from General Settings to 'Localisation'. Where, you can edit the language settings.
2. Via a connected management system; Go to the language settings screen on the management platform. Every Alfen charging station has the 'Language' setting item. The table below provides an overview of the languages supported.

Language	Country code	Language	Country code	Language	Country code	Language	Country code	Language	Country code
Dutch	nL_NL	German	de_DE	Spanish	es_ES	Italian	it_IT	Swedish	sv_SE
English	en_GB	French	fr_FR	Portugese	pt_PT	Norwegian	nn_NO	Finnish	fi_FI

4.5 Activate functionality with the Service Installer application

The charging station is connected to Alfen through the Service Installer application. When necessary, you can retrieve the last known settings. This makes it possible to go back to factory settings or to retrieve new settings.

Alfen charging stations offer the unique possibility to be upgraded with new functionalities, even if these did not yet exist when the station was purchased. Returning to factory settings or retrieving a new 'license' will be sufficient. If the option is then activated, you can use and install it as desired.

5.1 Management systems

Alfen charging stations are intelligent, and can communicate with a range of online third party management systems or our own, Alfen ICU EZ. All of these provide the opportunity to track users' energy consumption, control charging remotely and simplify charge point maintenance via remote access.

Each charging station is already configured to directly connect with the chosen management system at point of manufacture, with internet connection established via GPRS or a UTP (Ethernet) cable connection depending on the model and/or customer preference. Where a GPRS connection is available, and was specified, the charge point is usually supplied with the SIM card installed and will connect automatically once the product is powered on. If the SIM card holder (item. ⑦ on page 3, optional with S-line 3-phase) does not contain a SIM card, it will either be included in the package or can be back-ordered. If in doubt, please contact the reseller or provider.

or more information on the Alfen management system ICU EZ, visit: www.alfen.com/en/ev-charge-points/services

5.2 Setting up a connection

5.2.1 Wireless connection

To connect wirelessly, the charging station must be equipped with a SIM card suitable for GPRS. The correct settings must also be chosen to connect with the desired management system.

There are several (shortcuts) in the Service Installer to support this. These allow easy selection of the desired management system and related settings. Always check the signal strength after installation, using the Service Installer.

REMARK

Whether and which management system a charging station connects to is arranged by the company reselling the product. This includes the services offered via this system, which are outside the scope of delivery of Alfen.

Where Alfen ICU Connect online management system was specified when ordering, the Eve Single will already have a SIM card installed and will connect automatically when the product is powered on. If you chose another management system when ordering, you might need to install the SIM card yourself. Figure 9 shows the location of the SIM cardholder.

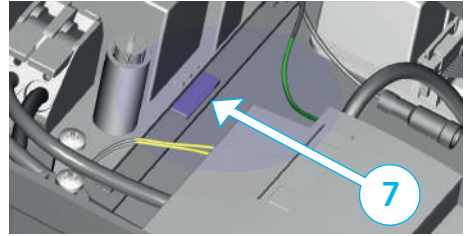

Figure 9: Location of SIM cardholder

! WARNING

The SIM cardholder needs to be handled with the utmost care. To access the SIM cardholder, disconnect the transparent subframe (3 x Torx T20 screw). To install a card, access the SIM cardholder from the left side. This will provide you with more space. Be careful not to crush any cables while replacing the subframe.

5.2.2 UTP (Ethernet) connection

Which cable do you need?

A CAT5 UTP cable (max. 20 metres) is the minimum required to connect the charging station to the internet. This cable is suitable for speeds up to 100Mbps.

Installation

1. Connect the UTP cable to your router.
2. Make sure the charging station is turned off (de-energised) at the local installation.
3. Feed the UTP cable in through one of the grommets on the rear of the casing. Then, fix the connector onto the cable and connect to the Ethernet port on the upper left-hand corner on the charging station controller (Ⓢ on pages 2 and 3). Use the right RJ45 connector for a solid core or flex core cable. A connector suitable for both types is also sufficient. Be careful not to damage the core(s).
4. Connect the charging station as described in paragraph 3.4 and then turn on the power supply on the local installation.
5. In order for your charging station to communicate with ICU EZ via an UTP Ethernet connection, it may be necessary to change your network settings if these are additionally secured. The necessary information to obtain access through your network is:
 - IP address ICU EZ: 93.191.1.28.6
 - Port: 9090
 - FTP port: 21
 - Inbound - outbound

5. CONNECTIVITY

It might be necessary to add a MAC address. You can find this in the Network Settings tab in the Service Installer application.

REMARK

Make sure your network settings allow connection to the Alfen servers through a secured FTP connection. This enables software updates and the exchange of diagnostics.

5.3 Register your ICU EZ account

If you want to enter into a contract for ICU EZ management services with Alfen, visit: www.alfen.com/en/services/management-charging-stations to register.

REMARK

You can only register as a user once you own the ICU EZ charging station. In order to register, you will need the information for your first charging station. We use this information to identify you. As soon as your account has been set up, Alfen will contact you with login details. Did you forget to register, but you have already ordered the ICU EZ? No problem. If you ordered the charging station to be configured to ICU EZ, your charging station is already registered and active in the management system. All transactions and other actions from the past are saved and visible to you.

1. Complete the registration form on the Alfen website.
2. In the 'remarks' field, enter the numbers located on the back of your charge passes.
3. Click 'Send'.
4. Alfen will process your request and activate your account. Your login details will be sent as soon as possible.
5. With these login details, you will be able to log in to the website www.alfen.com/en/more/login.
6. After logging in on ICU EZ, you will be able to access your charging point and its status immediately.

5.4 Managing settings

If your charging station is connected to a management system, it is possible to manage settings remotely even without using the Service Installer application. Alfen charging stations offer a myriad of configuration possibilities, for everything from basic settings to advanced smart charge settings. These fall broadly into the following categories:

- General information, such as the present charging current and temperature
- General settings for the charging station like language, intensity of the status indications and load capacity
- Switching between RFID and Plug & Charge and
- Settings for transaction messages
- Smart charge settings
- Connectivity
- Smart Charging Network
- Overview of activated options (see paragraph 2.6) and possibility to change (license code)











Alfen innovates continuously. Settings are regularly added, extended, adjusted and removed. The latest version of all settings can always be found at: www.alfen.com/en/downloads

5.5 Register your charging station to your own management system









When using a non-Alfen management system, it is essential that you register the charging station model. The Eve Single model will send a ChargePointModel in accordance with OCPP specifications when logging in. The table in paragraph 2.5.1 indicates available options.

APPENDIX A: ERROR CODES AND PROBLEM-SOLVING



This appendix provides a description of, and advice related to, the error codes that can be generated by the Eve Single charging station. If you are not able to find a working solution, please contact the seller of the charging station, or contact Alfen Support using the contact information displayed on the back of this manual.

Display		Troubleshooting		
Code	Error message text	Icon	Possible causes	Possible solutions
Generic				
001	Not able to charge. Please call for support.		Unknown generic error.	Contact the service department of your charge point supplier.
Error inside charge point				
101	One moment please. Your charging session will resume shortly.		DC fault current (>6mA) detected by charging station.	One specific vehicle: Contact your car dealership. Multiple vehicles: Contact the service department of your charge point supplier.
102	Not able to charge. Please call for support.		Internal error. Unexpected or no voltage on output of power board.	Contact the service department of your charge point supplier. • Check powerboard.
104	Not able to charge. Please call for support.		Internal error. Voltage to low on internal power supply (power board).	Contact the service department of your charge point supplier. • Check powerboard.
105	Not able to charge. Please call for support.		Internal error. No communication with internal power meter.	Contact the service department of your charge point supplier. • Check if internal power meter is connected correctly. • Check if internal power meter is configured correctly. • Check internal power meter.
106	Not able to charge. Please call for support.		Power interrupted by internal 30mA AC residual current protection device.	Contact your installation engineer. Internal RCD tripped.
Error in installation				
201	Error in installation. Please check installation or call for support.		Protective earth not connected or unstable.	Contact your installation engineer. • Recommended earth resistance of the installation < 100 Ohm.
202	Input voltage too low, not able to charge. Please call your installer.		Supply voltage below 210 VAC.	Contact your installation engineer.
206	Temporary set to unavailable. Contact CPO or try again later.		Charging station is set to inoperative by the Charge Point Operator / the charging station is updating.	Contact your charge point operator.
211	Not able to lock cable. Please call for support.		Unable to move locking motor during build-in self-test.	Contact your charge point operator. • Check if locking motor is connected correctly. • Check if locking motor can move.
212	Error in installation. Please check installation or call for support.		Missing phase in installation.	Contact your installation engineer. • Check voltage levels.

APPENDIX A: ERROR CODES AND PROBLEM SOLVING

Display		Troubleshooting		
Code	Error message text	Icon	Possible causes	Possible solutions
Error in car				
301	One moment please your charging session will resume shortly.		Unknown error in communication with car.	<ul style="list-style-type: none"> • Check car and charging cable. • Otherwise contact the service department of your charge point supplier.
302	One moment please your charging session will resume shortly.		Safety measure, Vehicle draws more power than allowed / did not reduce power in time according to the IEC 61851 norm.	<p>One specific vehicle: Contact your car dealership.</p> <hr/> <p>All vehicles: Contact the service department of your charge point supplier.</p>
303	One moment please your charging session will resume shortly.		Safety measure, charging is started too often within 1 minute.	<ul style="list-style-type: none"> • Check car and charging cable. • Otherwise contact the service department of your charge point supplier.
304	Charging not started yet to continue please reconnect cable.		Cable connected for more than 2 minutes without starting a charging session.	<ul style="list-style-type: none"> • Reconnect cable and start charging session within 2 minutes. • Otherwise contact the service department of your charge point supplier.
Error from outside (user, plug, cable, weather influences, etc.)				
401	Inside temperature high. Charging will resume shortly.		Temperature inside the charge point above 70 degrees Celsius.	<p>Unexpected:</p> <ul style="list-style-type: none"> • Ambient temperature. • No EV charging. <p>Contact the service department of your charge point supplier.</p> <hr/> <p>Expected:</p> <ul style="list-style-type: none"> • Ambient temperature. • Installed in direct sunlight. • EV charging. <p>Contact your installation engineer.</p>
402	Inside temperature low. Charging will resume shortly.		Temperature inside the charge point below -40 degrees Celsius.	<p>Unexpected ambient temperature.</p> <ul style="list-style-type: none"> • Contact the service department of your charge point supplier. <hr/> <p>Expected ambient temperature.</p>
403	Charging not started yet to continue please reconnect cable.		Generic error.	Contact the service department of your charge point supplier.
404	Not able to lock cable. Please reconnect cable.		Unable to lock the charging cable.	<p>Contact the service department of your charge point supplier.</p> <ul style="list-style-type: none"> • Check socket and charging cable plug. • Check if the lock motor can move freely.

APPENDIX A: ERROR CODES AND PROBLEM SOLVING

Display		Troubleshooting			
Code	Error message text	Icon	Possible causes	Possible solutions	
Error from outside (user, plug, cable, weather influences, etc.)					
405	Cable not supported. Please try connecting your cable again.		Measure PP resistance of the charging cable is out of range according to the IEC 61851 norm.	<p>One specific cable:</p> <ul style="list-style-type: none"> Issues with other charge points. <hr/> <p>All cables:</p> <ul style="list-style-type: none"> No issue with other charge point. 	<p>Cable broken</p> <hr/> <p>Contact the service department of your charge point supplier.</p>
406	No communication with vehicle. Please check your charging cable.		Monitored CP voltage level is out of range according to the IEC 61851 norm.	<p>One specific cable:</p> <ul style="list-style-type: none"> Issues with other charge points. <hr/> <p>All cables:</p> <ul style="list-style-type: none"> No issue with other charge point. 	<p>Cable broken.</p> <hr/> <p>Contact the service department of your charge point supplier.</p>

APPENDIX B: DEFAULT SELECTIONS FOR OPTIONAL FACTORY SETTINGS

The Eve Single charging station has the following Smart Charge options:

1. **Active load balancing:** this offers the same functionality for managing charging speeds as the default load balancing in double charging stations. Managing the maximum charging current now, however, is a dynamic process. The charging station communicates with the smart meter in your installation or home and takes the current usage and maximal capacity of your grid connection into account.
2. **Smart Charging Network (SCN):** When activated, Alfen charging stations will recognise each other within a local network, a so-called charging plaza. In that case, the local grid settings are shared between the charging stations. Together, the charging stations decide how much power each outlet - provided a vehicle is connected - will be allocated. To simplify the order process of smart charge functionalities, a number of parameters have been provided with default settings. This appendix provides the values of these settings. If your installation needs different settings from these defaults, use the Service Installer to configure the charging station for your specific situation.

B.1. Active load balancing

Requirements for the installation:

- Alfen charging points with activated Active Load balancing functionality.
- Communication cable with 4-veined RJ11/RJ12 connectors.
- Smart meter supporting one of the following protocols:
 - DSMR or eSMR over a P1 port. See paragraph 2.5.6 for the supported versions of this protocol.
 - Modbus TCP/IP: the charging station will assume the role of the Modbus Master in this configuration. The smart meter is the Slave.



NOTICE!

Alfen recommends a maximum cable length of 20 metres, combined with the P1 port. Always check if the communication with the smart meter is working properly. The quality of the signals depend on several factors. Therefore, always limit the cable length to prevent risks concerning the signal. Alfen ICU B.V. is not liable for continuous and correct operation of the connection to the P1 meter and the quality of the transferred signals.

The charging station and the smart meter communicate via the P1 port. For this, the DSMR protocol is used (for supported versions, see paragraph 2.5.6). Periodically, information on current usage is exchanged. When the meter capacity is reached, the charging station will adjust the connected vehicle. This prevents the installation from overloading, otherwise the cost of the grid connection will unnecessarily go up. This functionality effectively makes for 'peak shaving', it controls the power supply during peak moments.

If the P1 port of the smart meter is already occupied by another device, you can use a splitter. For advice on splitters, please contact your dealer.



NOTICE!

Not all splitters can be used. 2-veined connectors cannot be used. In that case, your charging station might not be able to communicate with the smart meter. Alfen is not liable for continuous and correct operation of the connection to the P1 meter if it has multiple devices and/or splitters attached.

To set up the active load balancing correctly, set the following parameters:

- Station-maxCurrent; This limits the maximum current on the charging station group.
- SmartMeter-maxCurrent; This is the capacity of your grid connection. When in doubt, check this with your grid operator.
- Load balancing safe current (A): the value of the current that remains available for the charging station (or charging plaza) when the connection between the energy meter and the charging station is lost.

APPENDIX B: DEFAULT SELECTIONS FOR OPTIONAL FACTORY SETTINGS

The table below provides the default settings for the parameters indicated:

Settings for maximum input current	At the outlet	Assumed settings	Active Load balancing on 1-phase connection	Active Load balancing on 3-phase connection
16A per phase	1 x 3.7kW 1 x 11kW	Station-MaxCurrent	16	16
		SmartMeter-MaxCurrent	25	25
32A per phase	1 x 7.4kW 1 x 22kW	Station-MaxCurrent	32	32
		SmartMeter-MaxCurrent	40	35

If these values do not apply to your situation, have the installer adjust the settings using the Service Installer application.

Modbus TCP/IP settings

In order for smooth communication with the smart meter through the Modbus TCP/IP, both need to be installed in the same network. Before reading out all necessary data fields, the smart meter and the charging station need to be able to communicate. For that, the following settings are important:

- Port: 502
- IPv4 addresses (use fixed IP address), assigned by the network operator
- Subnet mask of the local network
- Modbus address of the energy meter
- Default gateway of the local network

Factory settings	Options	Values
SCN-NetworkName	Name of the SCN	Maximum of 8 characters
SCN-SocketID	Unique ID of a socket within an SCN. For a charging station with two sockets, this identification represents socket 1.	0-255
SCN-SocketCount	The total amount of sockets in the SCN.	Maximum 100
SCN-AlternatingPeriod	The alternating period used in the event of insufficient capacity. This characteristic is automatically synchronised between charging stations within an SCN.	Maximum 65535 (seconds)
SCN-TotalStaticCurrent	The maximum available capacity available for the SCN in amperes. This characteristic is automatically synchronised between charging stations within an SCN.	
SCN-SafeCurrent	This safety value is used as a fallback in case a charging station loses connection with the other stations. This characteristic is automatically synchronised between charging stations within an SCN.	
SCN-PhaseMapping-1	This characteristic shows how the charging station is connected to the installation (phase shifts)	1 = L1, 2 = L2, 3 = L3, 4 = L1L2L3, 5 = L1L3L2, 6 = L2L1L3, 7 = L2L3L1, 8 = L3L1L2, 9 = L3L2L1 Other values are invalid.

APPENDIX B: DEFAULT SELECTIONS FOR OPTIONAL FACTORY SETTINGS

The table below provides an overview of values that can be read. Because the charging stations adjust to the currents per phase (bold in the table), this is the minimal information necessary to operate the active load balancing.

Measured value	Step size	Data type
Voltage L1L2 [V]	0.01 [V]	UNSIGNED32
Voltage L2L3 [V]	0.01 [V]	UNSIGNED32
Voltage L3L1 [V]	0.01 [V]	UNSIGNED32
Voltage L1N [V]	0.01 [V]	UNSIGNED32
Voltage L2N [V]	0.01 [V]	UNSIGNED32
Voltage L3N [V]	0.01 [V]	UNSIGNED32
Frequency [Hz]	0.001 [Hz]	UNSIGNED32
Current L1 [A]	0.001 [A]	UNSIGNED32
Current L2 [A]	0.001 [A]	UNSIGNED32
Current L3 [A]	0.001 [A]	UNSIGNED32
Current N [A]	0.001 [A]	UNSIGNED32
Active Power Sum [W]	0.1 [W]	SIGNED32
Reactive Power Sum [VAr]	0.1 [VAr]	SIGNED32
Apparent Power Sum [VA]	0.1 [VA]	UNSIGNED32
Cos(phi) Sum []	0.001 []	SIGNED32
Active Power L1 [W]	0.1 [W]	SIGNED32
Active Power L2 [W]	0.1 [W]	SIGNED32
Active Power L3 [W]	0.1 [W]	SIGNED32
Reactive Power L1 [VAr]	0.1 [VAr]	SIGNED32
Reactive Power L2 [VAr]	0.1 [VAr]	SIGNED32
Reactive Power L3 [VAr]	0.1 [VAr]	SIGNED32
Apparent Power L1 [VA]	0.1 [VA]	UNSIGNED32
Apparent Power L2 [VA]	0.1 [VA]	UNSIGNED32
Apparent Power L3 [VA]	0.1 [VA]	UNSIGNED32
Cos(phi) L1 []	0.001 []	SIGNED32
Cos(phi) L2 []	0.001 []	SIGNED32
Cos(phi) L3 []	0.001 []	SIGNED32

B.2 Smart Charging Network

The Smart Charging Network (SCN) is the smart charging functionality that makes connected Alfen charging stations form a single charging plaza. For every outlet used, the network decides how fast it can charge, taking the total load into account. To achieve this, all connected charging stations exchange data on the current charging capacity for all users.

APPENDIX B: DEFAULT SELECTIONS FOR OPTIONAL FACTORY SETTINGS



Figure 1.0: Smart Charging Network with Eve Single models

To ensure the correct operation of an SCN, it is important that all settings are correctly configured. As soon as the communication for the charging stations is installed, the charging plaza will at least have the following settings:

- Total capacity for all charging stations combined.
- Maximum charging current per outlet: this is determined by the group in the local installation and the maximum charging current of the charging station.
- Minimum charging current per outlet; This setting is:
 - a security setting; when a charging station loses network connection, all charging stations will use this value. The charging station that lost connection will continue to charge on this minimal charging current while the other charging stations reserve this value, and will temporarily not utilize this.
 - Minimum speed as a preferred setting; as soon as an extra outlet is used for charging and the remaining capacity is not enough to supply the minimum, the outlets used will alternate; one will charge while the other pauses, in 15 minute intervals.
- Alternation period (pause) in the event of insufficient capacity; by default, this is 15 minutes. The administrator can change this, if desired.

Preconditions for a properly functioning Smart Charging Network:

- All charging stations are in the same network (subnet, IP range) By default, this is 169.254.x.x.
- CAT5 UTP/Ethernet cable (minimal), CAT6 for cable runs over 100m.
- Minimum 10Mbps network
- UDP port: 36549, inbound-outbound.
- Use the DHCP server, if possible.
- Without a DHCP server, the charging stations obtain an IP address via Auto-IP.
- All charging stations are fed from the same point, there is no layered electricity grid.

- An (existing) switch or router with a sufficient amount of connection points is available to connect all charging stations together.
 - Looping through from charging point to charging point is not possible.
 - Tip: Always make sure one port is available to connect a laptop with the Service Installer application. Otherwise, make sure the laptop is in the same subnet as the charging stations.

REMARK

If network components like a switch or router are to be installed outdoors, we strongly advise purchasing the components accordingly and installing them in a suitable installation cabinet.

Adding a charging station to the Smart Charging Network

With the Service Installer application, all charging stations in the Smart Charging Network will be set up at the same time. All charging stations within the same subnet will be identified by the Service Installer application.

You can initialise the Smart Charging Network from the Service Installer. Select the charging station, navigate through the 'Device' menu to 'Add to new SCN'. Next, follow these steps:

- Name your SCN (charging plaza).
- Next, click on another charging station and click '+'. The charging station will be added to the desired SCN. The charging station will assume the network settings.
- Repeat step 2 until all charging stations are added to the SCN.

It is possible that a charging station cannot be entered into the SCN. In that case, check:

- The station firmware. The SCN is a supported feature in versions 3.2 and newer. If an Alfen Eve has been selected. It must have firmware version 3.3 or newer.

APPENDIX B: DEFAULT SELECTIONS FOR OPTIONAL FACTORY SETTINGS

- If the functionality was purchased. The charging station will not be part of the SCN if you have not purchased this functionality. After you receive confirmation for your purchase of this functionality by Alfen, the new functionality can be downloaded using the Service Installer application.



NOTICE!

After setting up a Smart Charging Network, all newly added charging stations will need to reboot. After rebooting, the charging stations will log in to the Smart Charging Network.

About OCPP

The functionalities of the SCN are available through the UTP/Ethernet connection of the charging stations. This can easily be combined with communication over OCPP, through UTP/Ethernet or GPRS. Note that you need one SIM card per charging station. To limit costs, you can also use a router and a (2G/3G/4G) modem. In that case, the charging stations should be set to communicate with a wired network. The router is then set for the (secure) APN of the relevant management system.

How to set up

Network choice	Per charging station	OCPP settings
Smart Charging Network with OCPP GPRS	SCN ON	OCPP Management System Selection for GPRS
Smart Charging Network with OCPP GPRS	SCN ON	OCPP Management System selection for UTP
Smart Charging Network with OCPP through external GPRS router	SCN ON	OCPP Management System selection for UTP
Electrical supply (local installation)	See paragraphs 2.5.11 and 2.5.12, always set to full power per charging station.	
Settings	Factory settings: set for charging station (max output)	

REMARK

Want to know more about the Smart Charging Network? Contact our Sales department or Sales Support via cpadmin@alfen.com

Electrical and electronic equipment (EEE) contains materials, components and substances that may be hazardous and present a risk to human health and the environment when waste electrical and electronic equipment (WEEE) is not handled correctly.

Equipment marked with the below crossed-out wheeled bin is electrical and electronic equipment.

The crossed-out wheeled bin symbol indicates that waste electrical and electronic equipment should not be discarded together with unseparated household waste, but must be collected separately.

For this purpose all local authorities have established collection schemes under which residents can dispose waste electrical and electronic equipment at a recycling centre or other collection points, or WEEE will be collected directly from households. More detailed information is available from the technical administration of the relevant local authority.

Users of electrical and electronic equipment must not discard WEEE together with household waste. Residents must use the municipal collection schemes to reduce adverse environmental impacts in connection with disposal of waste electrical and electronic equipment and to increase opportunities for reuse, recycling and recovery of waste electrical and electronic equipment.



Contact / Contact / Kontakt / Contact / Yhteystiedot

Alfen ICU B.V.
Hefbrugweg 28
1332 AP Almere
The Netherlands

P.O. box 1042
1300 BA Almere
The Netherlands

Tel. Sales Support: +31 (0)36 54 93 402
Tel. Service: +31 (0)36 54 93 401
Website: www.alfen.com/en/ev-charge-points
www.alfen.com/nl/laadpalen-ev
www.alfen.com/de/ladestationen-ev
www.alfen.com/fr/bornes-de-charge-ev

Art.nr. 203130036-ICU

